

[544] Cassandra Partitioning

Tyler Caraza-Harter

Learning Objectives

- identify strengths and weaknesses of different partitioning techniques
- interpret a token ring to assign a row of data to a Cassandra worker (assume single replication for now)
- describe how gossip can be used to replicate data across workers in a cluster, without need for a centralized boss

Cassandra Influences

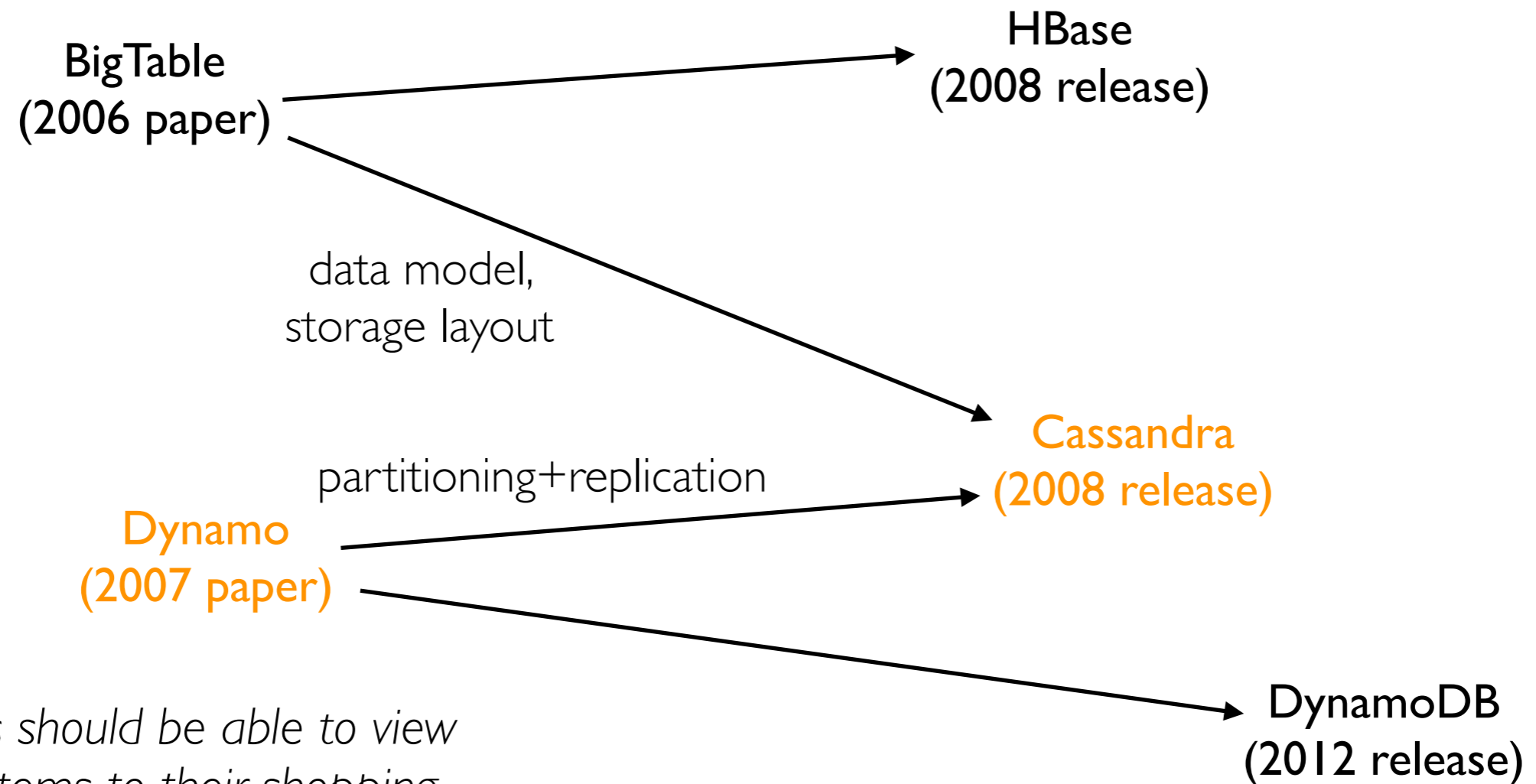

"customers should be able to view and add items to their shopping cart even if disks are failing, network routes are flapping, or data centers are being destroyed by tornados"
~ authors of first Dynamo paper

goal: highly available when things are failing

Partitioning Approaches

Given many machines and a partition of data, *how do we decide where it should live?*

Mapping Data Structure

- locations = {"fileA-block0": [datanode1, ...], ...}
- **HDFS** NameNode uses this

Hash Partitioning

- partition = $\text{hash}(\text{key}) \% \text{partition_count}$
- **Spark** shuffle uses this (for grouping, joining, etc); data structures associate partitions with worker machines

Consistent Hashing

- **Dynamo** and **Cassandra** use this

Review: HDFS Partitioning

My Laptop

NameNode

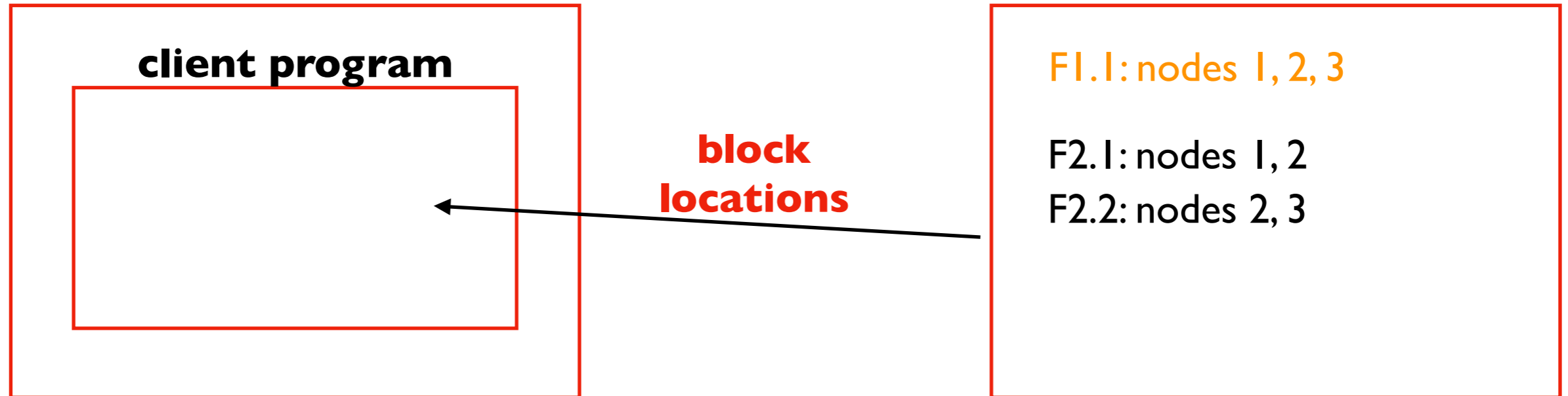

**DataNode
Computers**

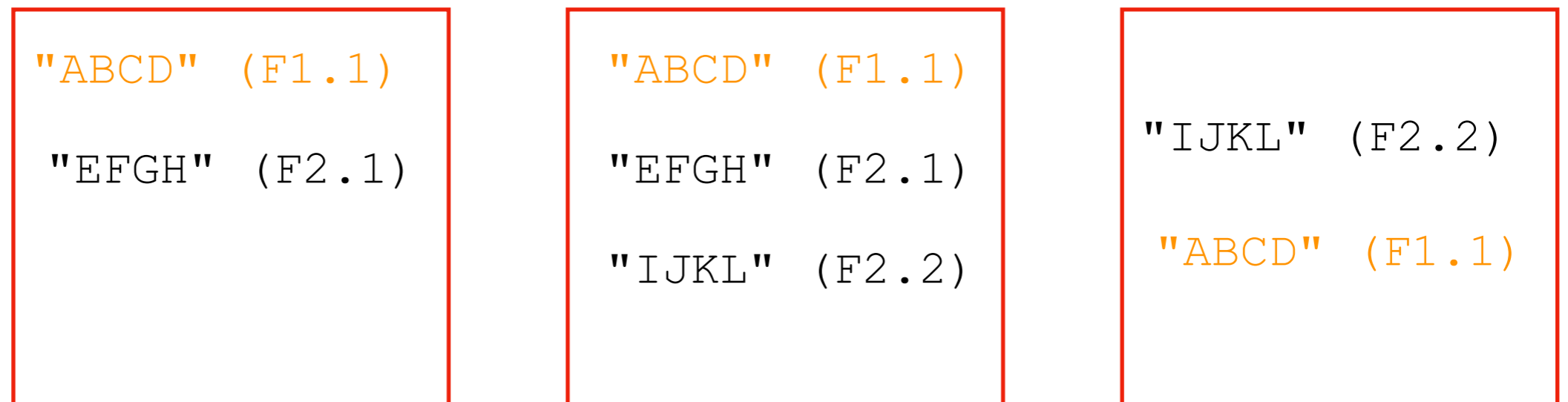

DNI

DN2

DN3

Review: Spark Hash Partitioning

□ partition

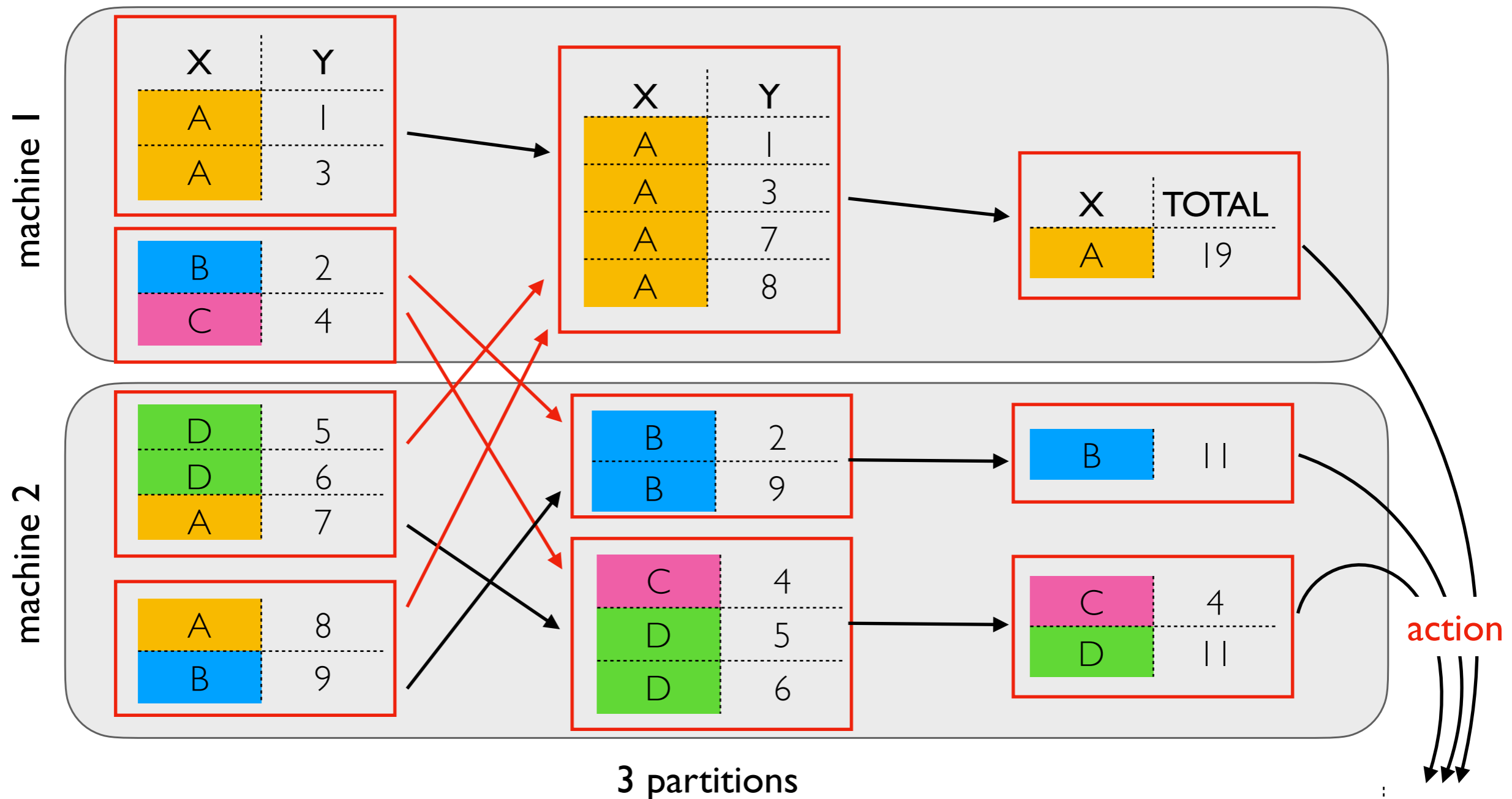

```
row = Row(X=D, Y=5)
partition = hash(row.X) % 3 # partition=2
```

file or Pandas DF

X	TOTAL
A	19
B	11
C	4
D	11

Discuss Scalability: HDFS and Spark

Scalability: we can make efficient use of many machines for big data

Some ways we can have big data:

- few **large** objects (files/tables)
- **lots** of small objects (files/tables)

Will HDFS struggle with either kind of big data? Spark?

Elasticity: Easily Growing/Shrinking Clusters

Incremental Scalability: can we efficiently add more machines to an already large cluster?

What happens when we **add a new DataNode** to an HDFS cluster?

What would need to happen if we able to **add an RDD partition** in the middle of a Spark hash-partitioned shuffle?

Elasticity: Easily Growing/Shrinking Clusters

Incremental Scalability: can we efficiently add more machines to an already large cluster?

What happens when we **add a new DataNode** to an HDFS cluster?

What would need to happen if we able to **add an RDD partition** in the middle of a Spark hash-partitioned shuffle?

Demo: hash partition 26 letters over 4 "machines".
Add a 5th machine. How many letters must move?

Partitioning Approaches

Given many machines and a partition of data, *how do we decide where it should live?*

Mapping Data Structure

- locations = {"fileA-block0": [datanode1, ...], ...}
- **HDFS** NameNode uses this

Hash Partitioning

- partition = $\text{hash}(\text{key}) \% \text{partition_count}$
- **Spark** shuffle uses this (for grouping, joining, etc); data structures associate partitions with worker machines

Consistent Hashing

- **Dynamo** and **Cassandra** use this
- token = $\text{hash}(\text{key})$ # every token is in a range, indicating the worker
- locations = {range(0,10): "worker1", range(10,20): "worker2", ...}

Consistent Hashing

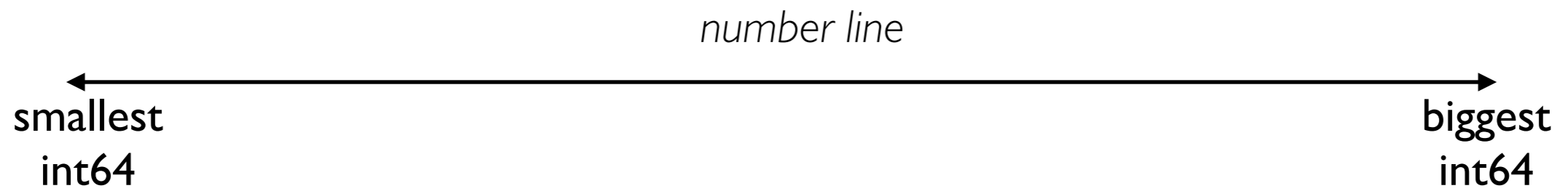

Consistent Hashing

Token Map:

token(node1) = pick something

token(node2) = pick something

token(node3) = pick something

workers:

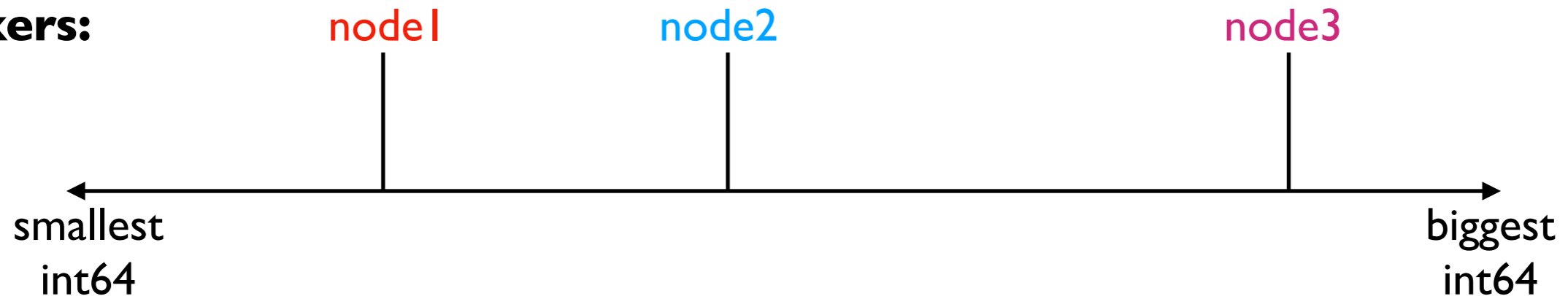

assign every **worker** a point on the number line.

Could be random (though newer approaches are more clever).

No hashing needed, yet!

Consistent Hashing

Token Map:

$\text{token}(\text{node1}) = \text{pick something}$

$\text{token}(\text{node2}) = \text{pick something}$

$\text{token}(\text{node3}) = \text{pick something}$

workers:

node1

node2

node3

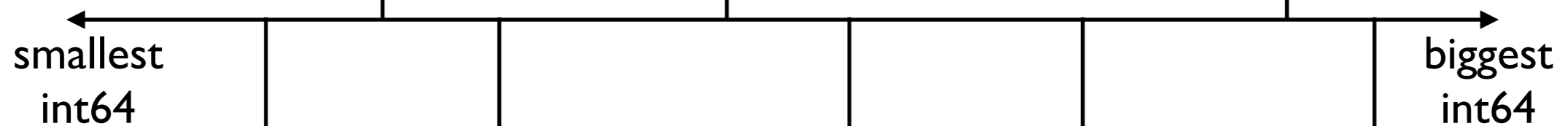

rows:

A

B

C

D

E

assign every **row** a point on the number line.

$\text{token}(\text{row}) = \text{hash}(\text{row's partition key})$

Consistent Hashing

Token Map:

token(node1) = pick something

token(node2) = pick something

token(node3) = pick something

workers:

node1

node2

node3

rows:

A

B

C

D

E

↑
belongs to node2

each node's token is the **inclusive end** of a range. A row is mapped to a node based on the range it is in.

cluster:

node1

node2

node3

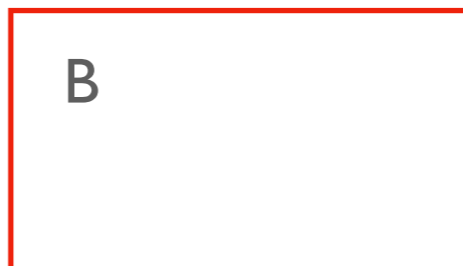
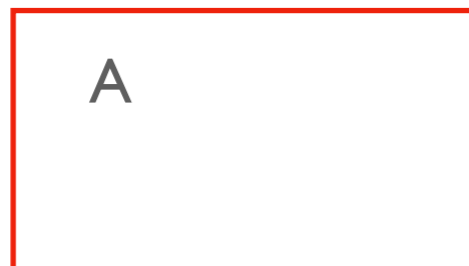

Consistent Hashing

Token Map:

token(node1) = pick something

token(node2) = pick something

token(node3) = pick something

workers:

node1

node2

node3

rows:

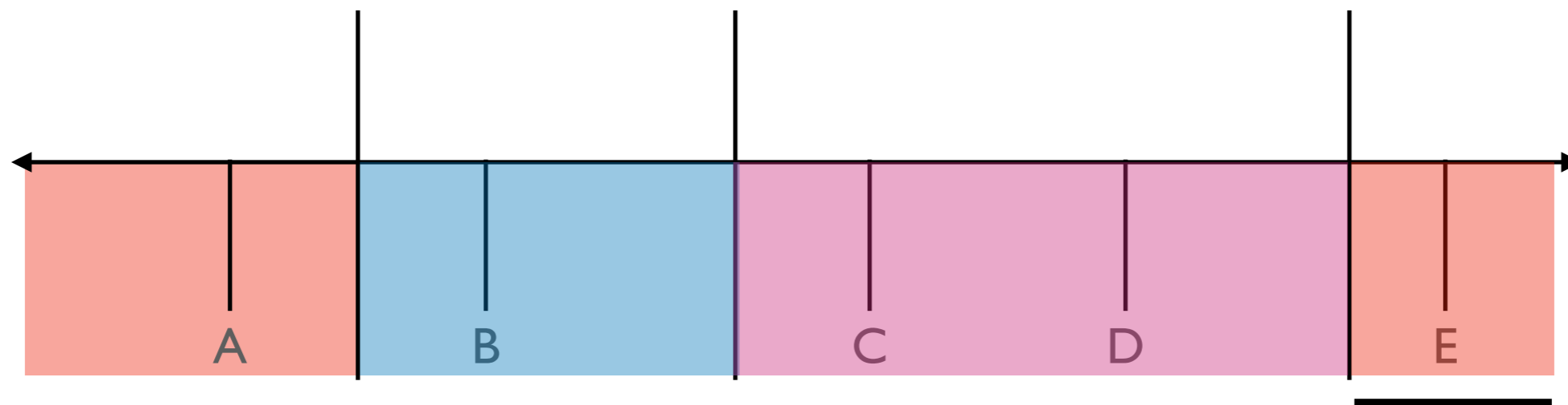

tokens > biggest node token are in the *wrapping range*. Rows in this region go to the node with the smallest token.

cluster:

node1

node2

node3



Alternate Visualization

Given the wrapping, clusters using consistent hashing are called "token rings"

Common visuazilation (e.g., from Wikipedia)

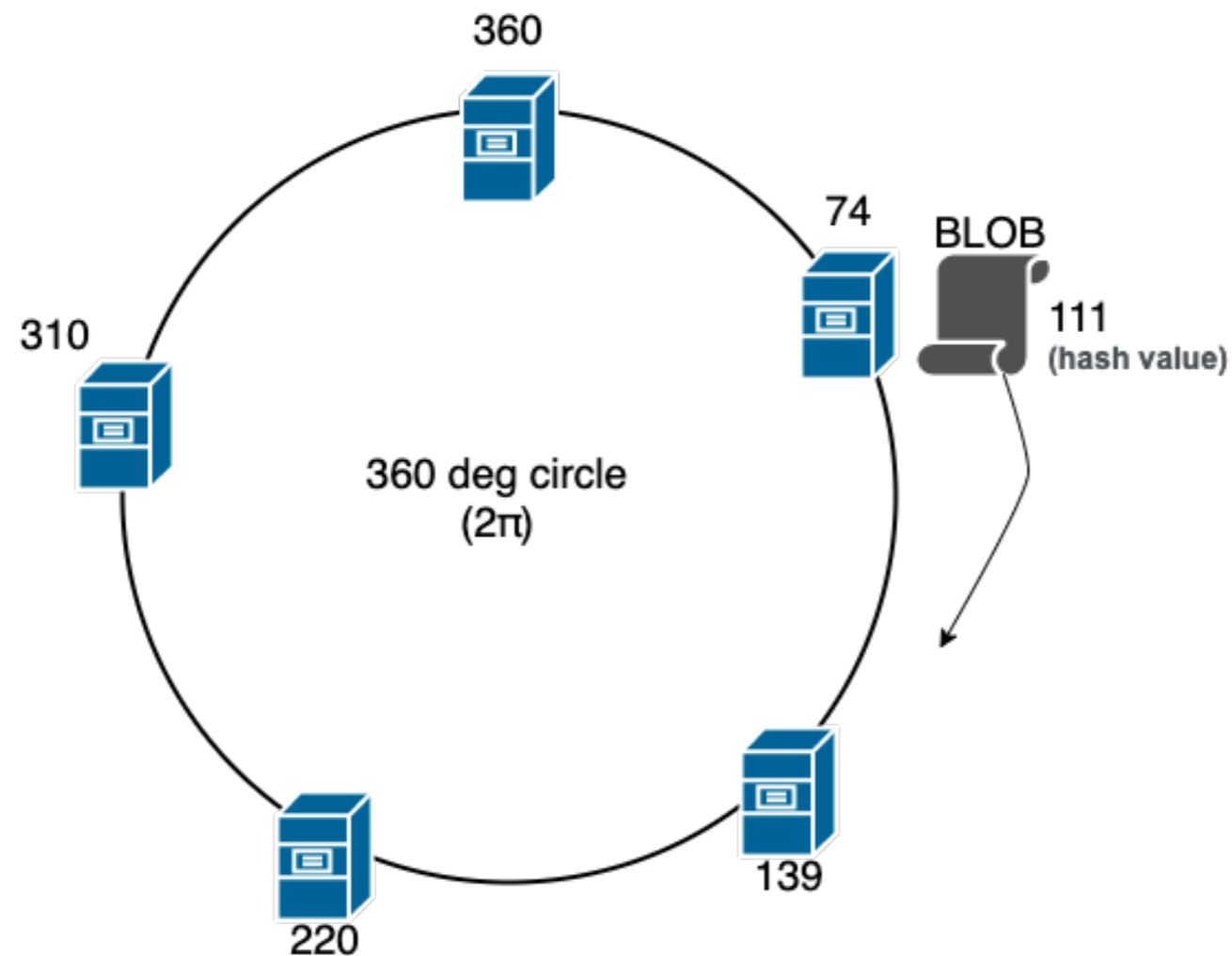

Adding a Node

Token Map:

token(node1) = pick something

token(node2) = pick something

token(node3) = pick something

token(node4) = pick something

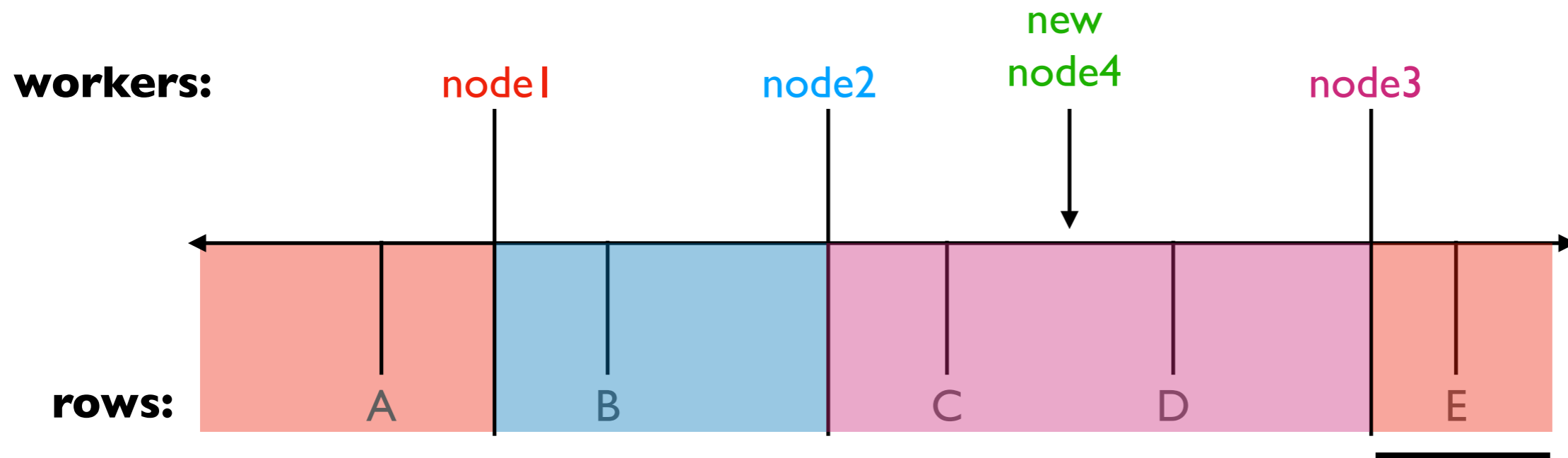

which rows will have to move?
which nodes will be involved?

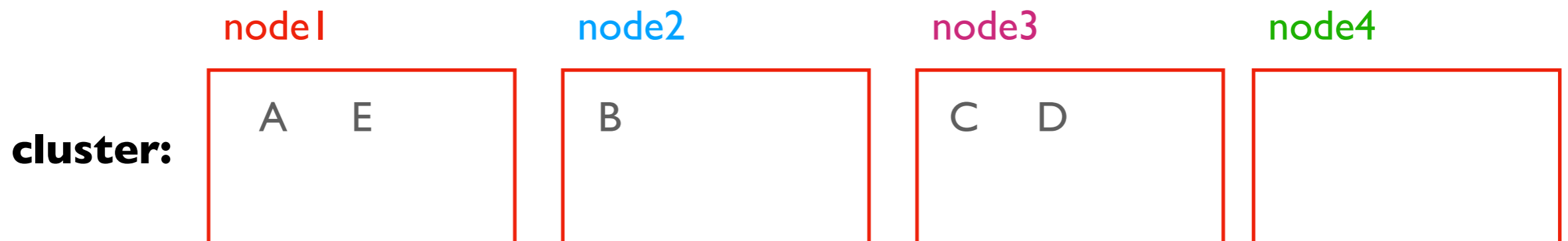

Adding a Node

Token Map:

token(node1) = pick something

token(node2) = pick something

token(node3) = pick something

token(node4) = pick something

workers:

node1

node2

node4

node3

rows:

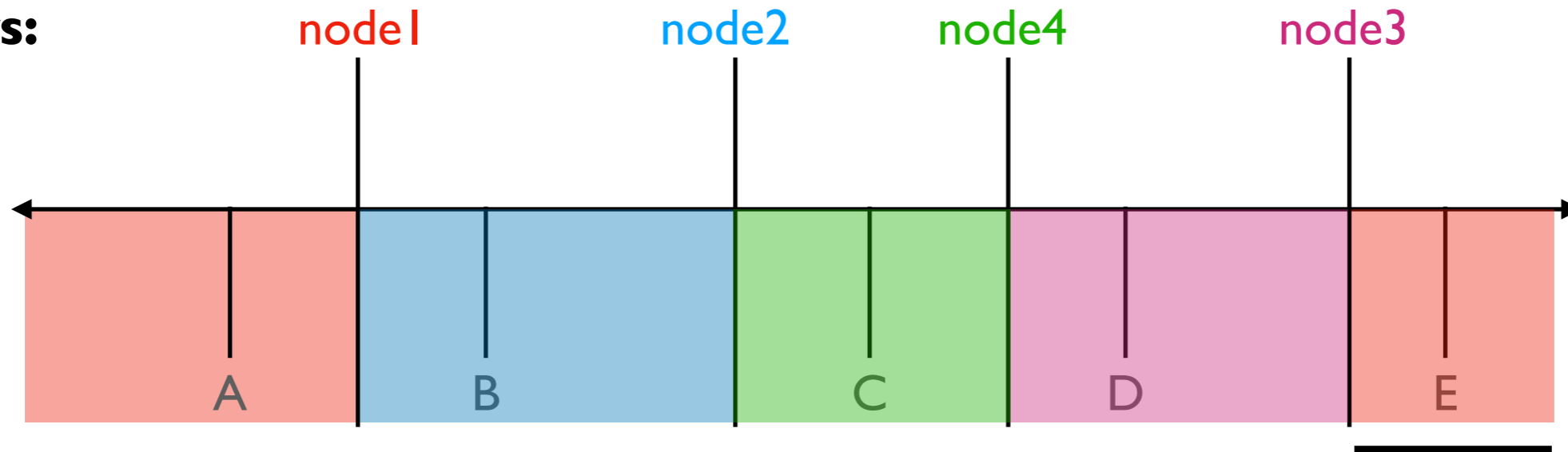

which rows will have to move? Only C

which nodes will be involved? Only node3 and node4

cluster:

node1

node2

node3

node4

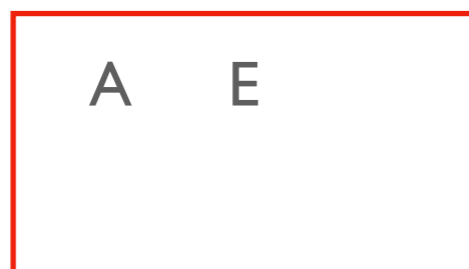

Adding a Node

Token Map:

token(node1) = pick something

token(node2) = pick something

token(node3) = pick something

token(node4) = pick something

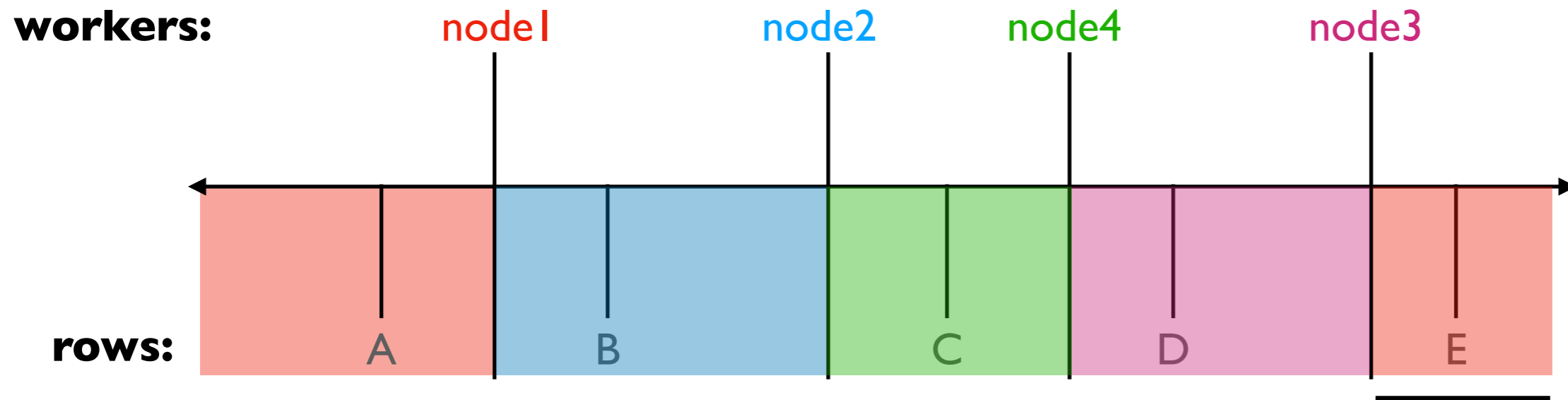

Typically, what fraction of the data must move when we scale from $N-1$ to N ?

Hash partitioning: about $(N-1)/N$ of the data

Consistent hashing: about $(\text{size of new range})/(\text{size of ring})$ of the data must move.

Collisions

Token Map:

token(node1) = pick something

token(node2) = pick something

token(node3) = pick something

token(node4) = pick something

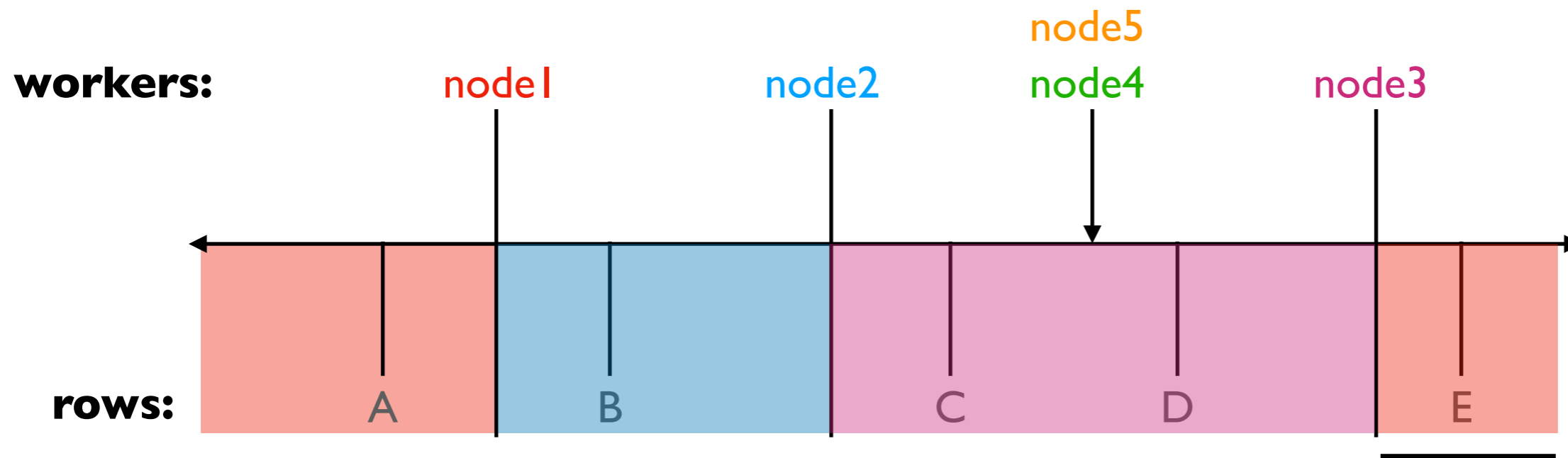

Problem: latest Cassandra versions by default try to choose new node tokens to split big ranges for better balance (instead of randomly picking). Adding multiple nodes simultaneously can lead to collisions, preventing nodes from joining.

Solution: add one at a time (after initial "seed" nodes)

Sharing the Work

Token Map:

token(node1) = pick something

token(node2) = pick something

token(node3) = pick something

token(node4) = pick something

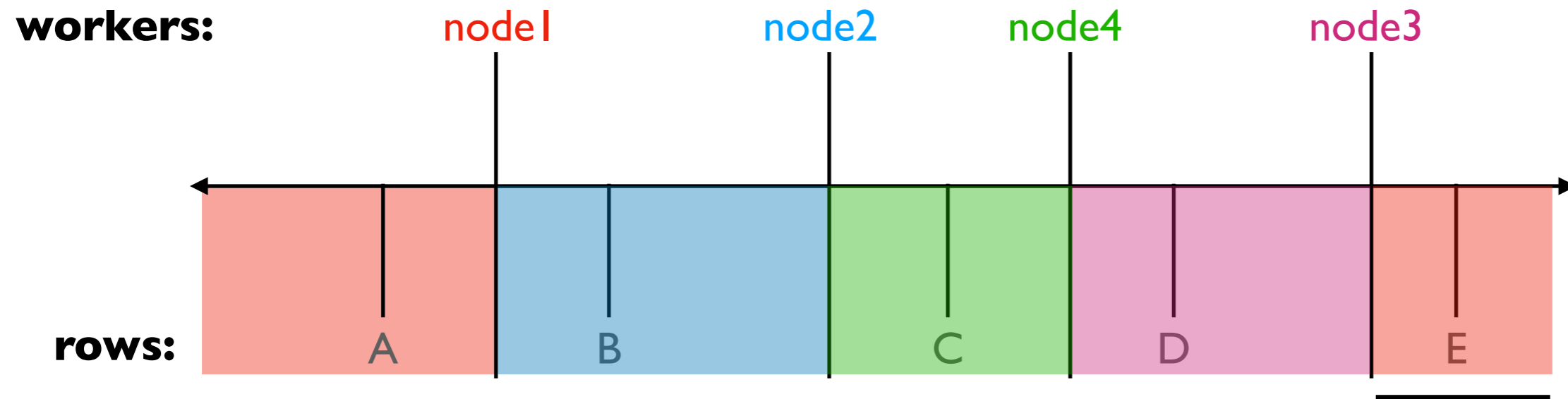

Other problems with adding node 4

- **long term:** only load of node 3 is alleviated
- **short term:** node 3 bears all the burden of transferring data to node 4

Solution: "vnodes"

Virtual Nodes (vnodes)

Token Map:

token(node1) = {t1, t2}

token(node2) = {t3, t4}

token(node3) = {t5, t6}

token(node4) = {t7, t8}

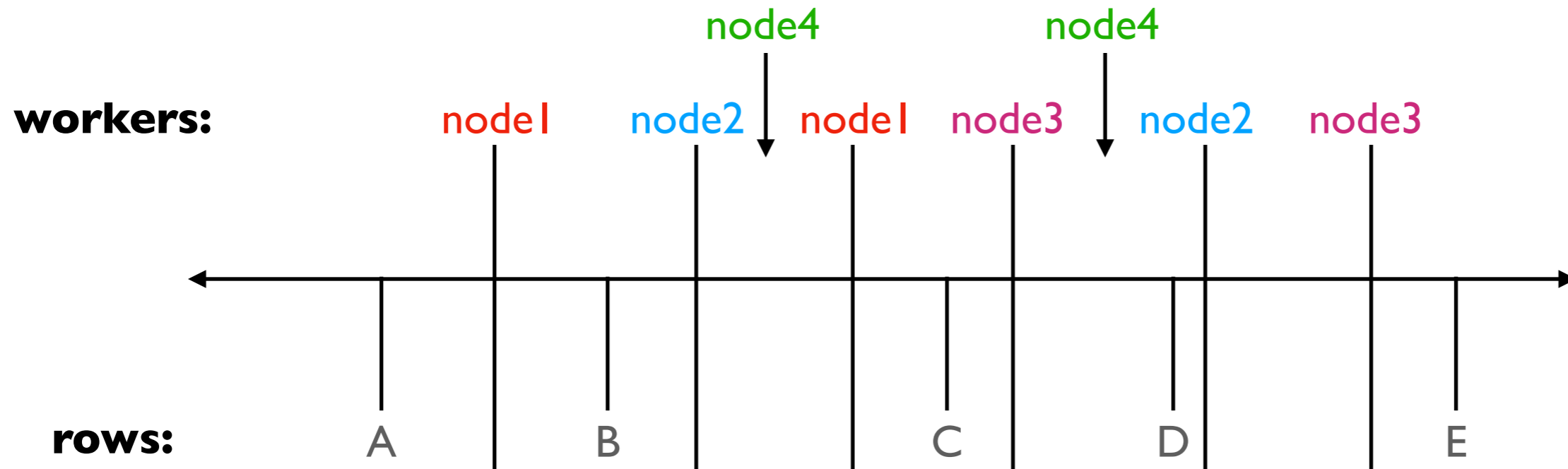

Each node is responsible for multiple ranges

- how many is configurable
- node 4 will take some load off nodes 1 and 2 (those to the right of its vnodes)

Heterogeneity

Token Map:

token(node1) = {t1, t2}

token(node2) = {t3, t4}

token(node3) = {t5, t6}

token(node4) = {t7, t8, t9, t10}

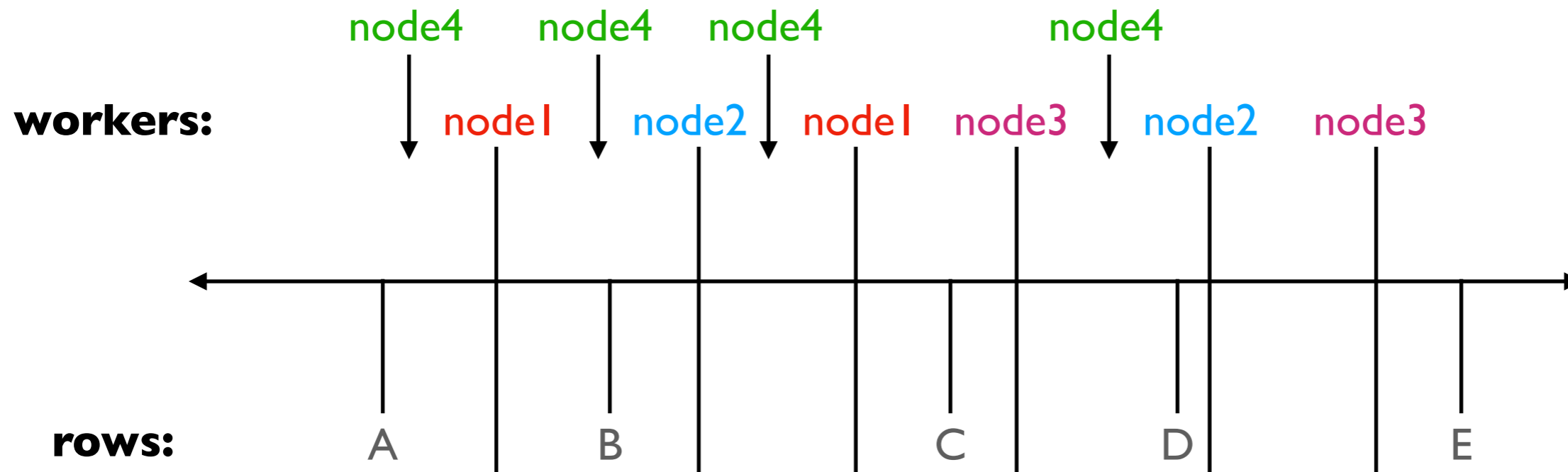

Heterogeneity: some machines (e.g., newer ones) have more resources

- more powerful nodes can have more vnodes
- probabilistically, they'll do more work and store more data

Token Map Storage

Token Map:

token(node1) = {t1, t2}

token(node2) = {t3, t4}

token(node3) = {t5, t6}

where should this live?



we don't want a single point of failure
(like an HDFS NameNode)

Token Map Storage

node1

table rows

...lots of data...

Token Map:

token(node1) = {t1, t2}

token(node2) = {t3, t4}

token(node3) = {t5, t6}

node2

table rows

...lots of data...

Token Map:

token(node1) = {t1, t2}

token(node2) = {t3, t4}

token(node3) = {t5, t6}

node3

table rows

...lots of data...

Token Map:

token(node1) = {t1, t2}

token(node2) = {t3, t4}

token(node3) = {t5, t6}

every node has a copy of the token map

they should all get updated when new nodes join

Adding Nodes: Bad Approach

uh oh, node 3 won't know about node 4 when it comes back

node1

table rows

...lots of data...

Token Map:

token(node1) = {t1, t2}

token(node2) = {t3, t4}

token(node3) = {t5, t6}

token(node4) = {t7, t8}

node2

table rows

...lots of data...

Token Map:

token(node1) = {t1, t2}

token(node2) = {t3, t4}

token(node3) = {t5, t6}

token(node4) = {t7, t8}

node3

table rows

...lots of data...

rebooting...

Token Map:

token(node1) = {t1, t2}

token(node2) = {t3, t4}

token(node3) = {t5, t6}

node4

table rows

...lots of data...

Token Map:

token(node1) = {t1, t2}

token(node2) = {t3, t4}

token(node3) = {t5, t6}

token(node4) = {t7, t8}

Better Approach: Gossip

just inform one or a few nodes
about the new one

node1

table rows

...lots of data...

Token Map:

token(node1) = {t1, t2}

token(node2) = {t3, t4}

token(node3) = {t5, t6}

node2

table rows

...lots of data...

Token Map:

token(node1) = {t1, t2}

token(node2) = {t3, t4}

token(node3) = {t5, t6}

token(node4) = {t7, t8}

node3

table rows

...lots of data...

rebooting...

Token Map:

token(node1) = {t1, t2}

token(node2) = {t3, t4}

token(node3) = {t5, t6}

node4

table rows

...lots of data...

Token Map:

token(node1) = {t1, t2}

token(node2) = {t3, t4}

token(node3) = {t5, t6}

token(node4) = {t7, t8}

Better Approach: Gossip

once per second:
choose a random friend
gossip about new nodes

node1

table rows

...lots of data...

Token Map:

token(node1) = {t1, t2}

token(node2) = {t3, t4}

token(node3) = {t5, t6}

token(node4) = {t7, t8}

node2

table rows

...lots of data...

Token Map:

token(node1) = {t1, t2}

token(node2) = {t3, t4}

token(node3) = {t5, t6}

token(node4) = {t7, t8}

"have you heard
about node 4?"



node3

table rows

...lots of data...

rebooting...

Token Map:

token(node1) = {t1, t2}

token(node2) = {t3, t4}

token(node3) = {t5, t6}

node4

table rows

...lots of data...

Token Map:

token(node1) = {t1, t2}

token(node2) = {t3, t4}

token(node3) = {t5, t6}

token(node4) = {t7, t8}

Better Approach: Gossip

eventually, every node should find out

node1

table rows

...lots of data...

Token Map:

token(node1) = {t1, t2}

token(node2) = {t3, t4}

token(node3) = {t5, t6}

token(node4) = {t7, t8}

node2

table rows

...lots of data...

Token Map:

token(node1) = {t1, t2}

token(node2) = {t3, t4}

token(node3) = {t5, t6}

token(node4) = {t7, t8}

node3

table rows

...lots of data...

Token Map:

token(node1) = {t1, t2}

token(node2) = {t3, t4}

token(node3) = {t5, t6}

token(node4) = {t7, t8}

node4

table rows

...lots of data...

Token Map:

token(node1) = {t1, t2}

token(node2) = {t3, t4}

token(node3) = {t5, t6}

token(node4) = {t7, t8}



Better Approach: Gossip

when a client wants to write a row,
they can contact any node -- it should
know where the data should live and
coordinate the operation

node1

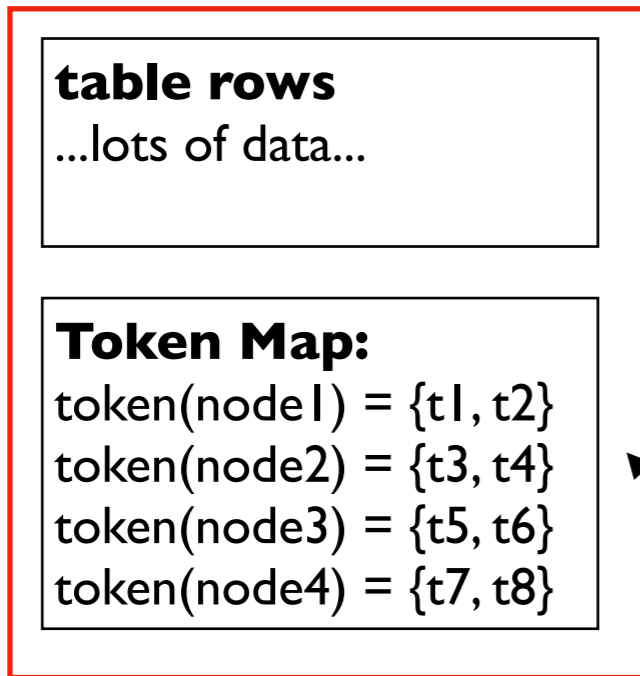

node2

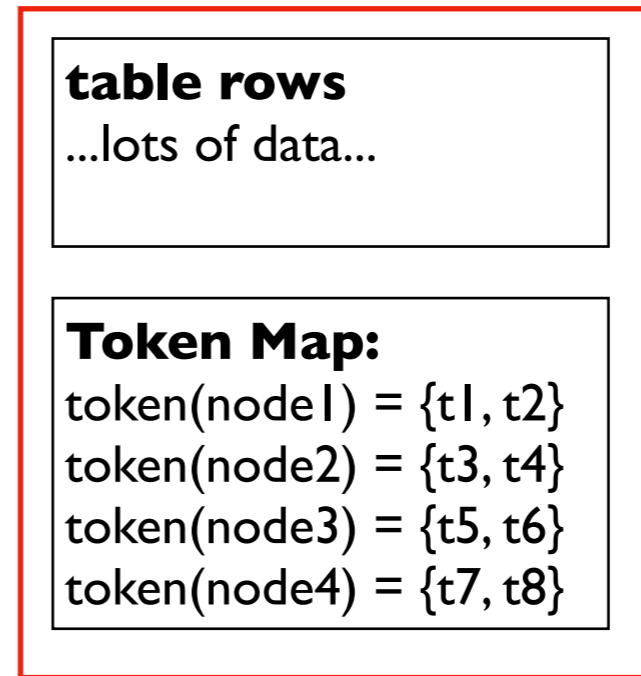

node3

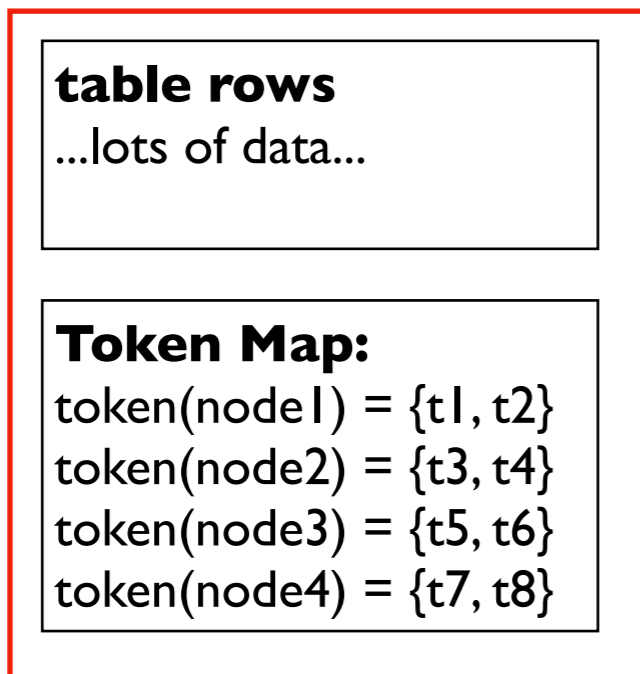

node4 (coordinator)

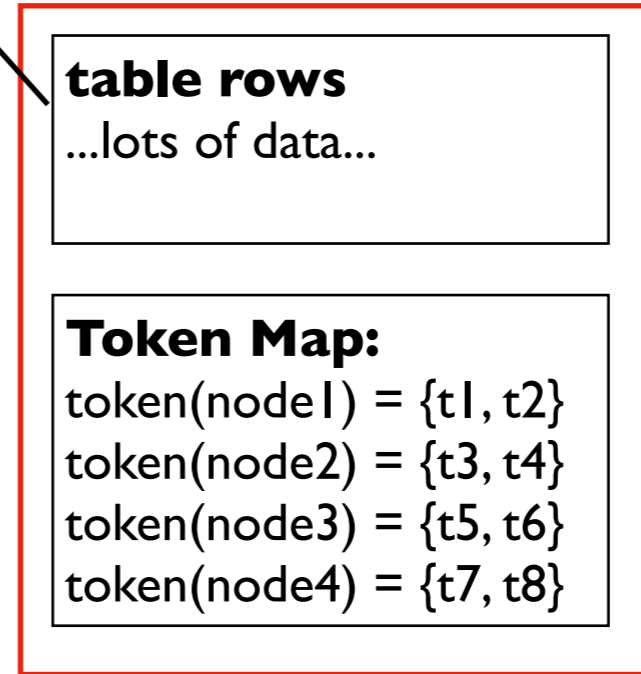

client

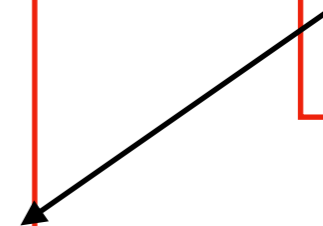
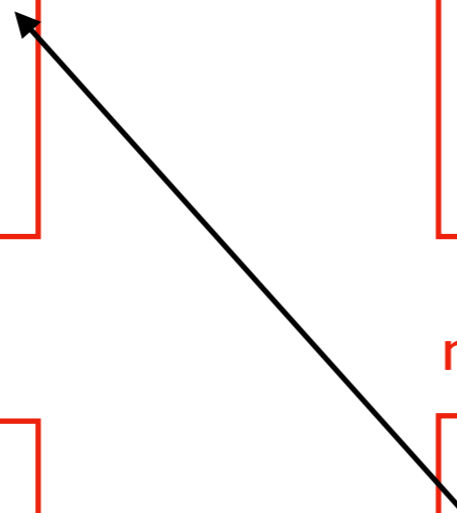
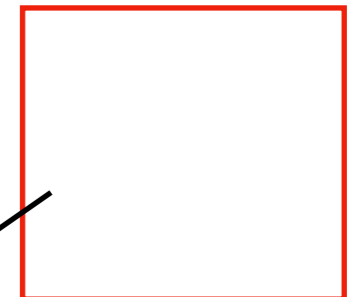

TopHat, Worksheet